

A4

1

2

3

4

5



6

 タカラ産業株式会社

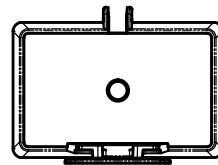
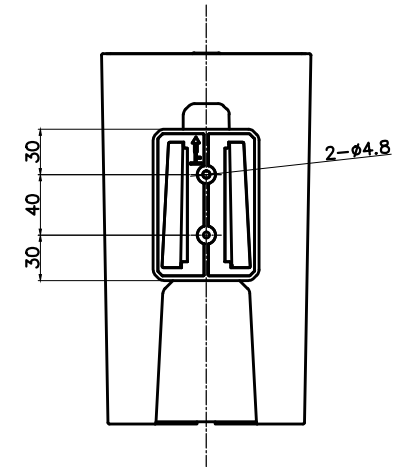
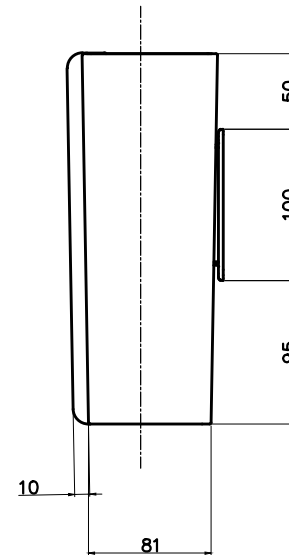
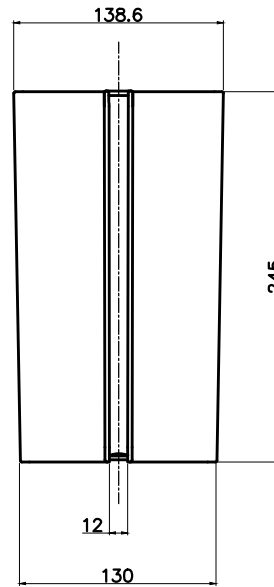
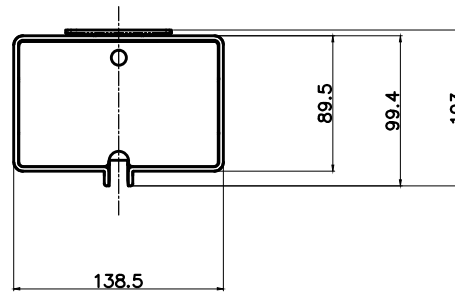
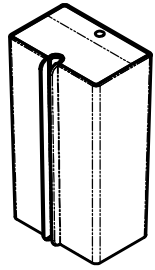
製作図  
2014.04.30  
開発設計

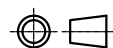

△			
△			
△			
記号	日付	履歴記事	担当

	尺度	作成日	検図	検図	作図
	1:5	2013.05.14	**	田中	二口
品名	品番		図面コードNo.		
縦型ペーパーホルダー	PTH200				

1

2

3

4

5

6